

# MODEL 5003

Installation and Operating Manual

SINGLE OR MULTI-POINT  
VERTICALLY MOUNTED  
LIQUID LEVEL FLOAT SWITCH



**Innovative Solutions**

60 Great Hill Road  
ph: 203-729-6434

Naugatuck, CT 06770  
fax: 203-729-6696

[www.innovativesensing.com](http://www.innovativesensing.com)

---

## Read this Manual Before Installing

This manual provides information on the S003 Liquid Level Float Switch. It is important that all instructions are read carefully and followed in sequence. Detailed installation and wiring instructions are included in this manual.

## Conventions Used in this Manual

Certain conventions are used in this manual to convey specific types of information. General technical material, support data, and safety information are presented in narrative form. The following styles are used for notes, cautions, and warnings.

### NOTES

Notes contain information that augments or clarifies an operating step. Notes do not normally contain actions. They follow the procedural steps to which they refer.

### Cautions

Cautions alert the technician to special conditions that could injure personnel, damage equipment, or reduce a component's mechanical integrity. Cautions are also used to alert the technician to unsafe practices or the need for special protective equipment or specific materials. In this manual, a caution box indicates a potentially hazardous situation which, if not avoided, may result in minor or moderate injury.

## Notice of Trademark, Copyright, and Limitations

Copyright © 2009 Solutions With Innovation LLC; D.B.A. Innovative Solutions  
All rights reserved.

Performance specifications are effective with date of issue and are subject to change without notice. Innovative Solutions reserves the right to make changes to the product described in this manual at any time without notice. Innovative Solutions makes no warranty with respect to the accuracy of the information in this manual.

## Warranty

All Innovative Solutions mechanical level and flow controls are warranted free of defects in materials or workmanship for one full year from the date of original factory shipment.

If returned within the warranty period; and, upon factory inspection of the control, the cause of the claim is determined to be covered under the warranty; then, Innovative Solutions will repair or replace the control at no cost to the purchaser (or owner) other than transportation.

Innovative Solutions shall not be liable for misapplication, labor claims, direct or consequential damage or expense arising from the installation or use of equipment. There are no other warranties expressed or implied, except special written warranties covering some Innovative Solutions products.

## Quality Assurance

The quality assurance system in place at Innovative Solutions guarantees the highest level of quality throughout the company. We are committed to providing full customer satisfaction both in quality products and quality service.

---

# MODEL 5003

## SINGLE OR MULTI-POINT VERTICALLY MOUNTED LIQUID LEVEL FLOAT SWITCH

### Table of Contents

#### 1.0 Installation

1.1 Unpacking.....	1
1.2 Before You Begin .....	1
1.2.1 Site Preparation.....	1
1.2.2 Equipment and Tools .....	1
1.3 Mounting.....	2
1.3.1 Bracket Mounting.....	2
1.4 Wiring .....	2

#### 2.0 Preventative Maintenance

2.1 What to do.....	3
2.1.1 Inspect Connections Monthly .....	3
2.1.2 Inspect Entire Unit Periodically.....	3
2.2 What to Avoid.....	3

#### 3.0 Reference Information

3.1 Description .....	4
3.2 Theory of Operation .....	4
3.3 Troubleshooting.....	4
3.3.1 External Causes .....	4
3.3.2 Unit Causes.....	5
3.4 Specifications .....	6
3.4.1 Float Specifications .....	6
3.4.2 Electrical Specifications.....	6
3.4.3 Switch Wiring Code .....	6
3.4.4 Custom Configurator.....	7
3.5 Replacement Parts .....	8
3.6 Product Configurator .....	9

---

## 1.0 Installation

This section provides detailed procedures for properly installing the Single or Multi-Point Vertically Mounted Liquid Level Float Switch.

**Caution:** If equipment is used in a manner not specified by manufacturer, protection provided by equipment may be impaired.

## 1.1 Unpacking

Unpack the instrument carefully. Inspect all units for damage. Report any concealed damage to the carrier within 24 hours. Ensure that all components have been removed from the packing material. Check all contents against the packing list and report any discrepancies to the factory. Record the serial and model numbers for future reference when ordering parts.

Model Number \_\_\_\_\_

Serial Number \_\_\_\_\_

## 1.2 Before You Begin

**Caution:** During the installation of the Single or Multi-Point Vertically Mounted Liquid Level Float Switch, the float area must be kept free of metallic particles that might be attracted to the magnet inside the float.

### 1.2.1 Site Preparation

1. Ensure that the length and mounting is sized correctly for the Single or Multi-Point Vertically Mounted Liquid Level Float Switch.

### 1.2.2 Equipment and Tools

No special equipment or tools are required to install the Single or Multi-Point Vertically Mounted Liquid Level Float Switch.

The following items are recommended:

- Wrenches, thread sealant, gaskets and/or bolting as appropriate for the process connection.

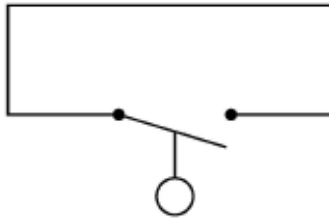

Fig. 1a - Normally Open SPST wiring diagram Dry Condition

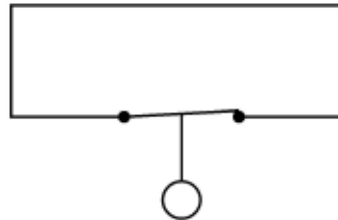

Fig. 1b - Normally Closed SPST wiring diagram Dry Condition

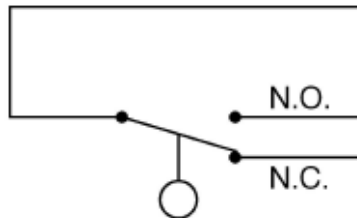

Fig. 2 SPDT wiring diagram Dry Condition

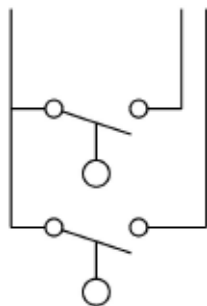

Fig. 3 Group 1 SPST One Common Wire 1 to 3 switch points

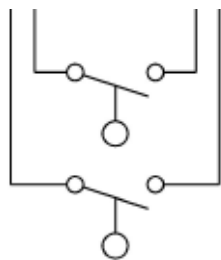

Fig. 4 Group 2 SPST Independant Circuits 1 to 3 switch points

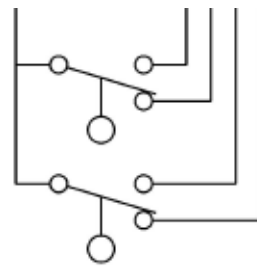

Fig. 5 Group 3 SPDT One Common Wire 1 or 2 switch points

## 1.3 Mounting

The Single or Multi-Point Vertically Mounted Liquid Level Float Switch is available with a variety of bracket or flange mountings. These devices can be installed from the top of the tank. The switches should be mounted in an area clear of turbulence or direct streams. Contact factory for flanged mount options.

### 1.3.1 Bracket Mounting

Mount the level switch to the tank using the bracket or flange attached to the device. Position and tighten the securing screws.

## 1.4 Wiring

1. SPST reed switch: Connect wiring to switch leads or terminals per wiring diagram. See figure 1,3, or 4.
2. SPDT reed switch: Connect wiring to proper switch leads or terminals per wiring diagram. See figure 2 or 5.

**NOTE:** Observe all applicable electrical codes and proper wiring procedures.

### Contact Protection:

In order to take advantage of the long life, highly reliable characteristics of a reed switch, it is essential to provide protection when switching inductive loads. When current is interrupted, the inductance of the load generates a high frequency voltage, which appears across the switch contacts. If the voltage is large enough, it can cause arcing. Arcing can cause the contacts to weld to each other resulting in unreliable switching performance. It is essential to protect the circuit by suppressing the voltage to prevent arcing. This can be easily achieved through the use of a diode for DC circuits (Fig.6) and a resistor-capacitor network for AC circuits (Fig.7).

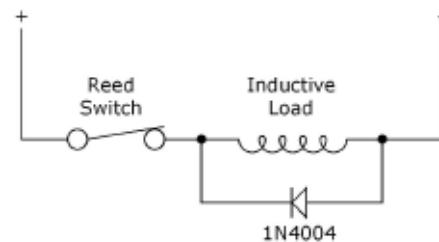

Fig. 6

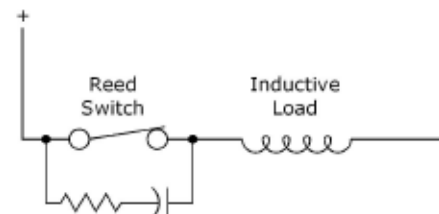

Fig. 7

---

## 2.0 Preventive Maintenance

Periodic inspections are a necessary means to keep your level control in good working order. This control is a safety device that protects the valuable equipment it serves. A systematic program of preventive maintenance should be implemented when the control is placed into service. If the following instructions are observed, your control will provide reliable protection of your equipment for many years.

### 2.1 What to Do

#### 2.1.1 Inspect Connections Monthly

The level switches may sometimes be exposed to excessive heat or moisture. Under such conditions insulation on electrical wires may become brittle, eventually breaking or peeling away. The resulting bare wires can cause short circuits. Check wiring carefully and replace at first sign of brittle insulation. Check all electrical connections to ensure that they are tight. Check wiring carefully and repair or replace if necessary.

#### 2.1.2 Inspect Entire Unit Periodically

A periodic cleaning of the float and rod will ensure continued free movement of the mechanism.

### 2.2 What to Avoid

1. NEVER leave the switch wiring exposed to the elements.
2. NEVER place a jumper wire across terminals to “cut-out” the control. If a jumper is necessary for test purposes, ensure that it is removed before placing the control into service.
3. NEVER use in systems containing iron particles. The magnet in the float assembly can attract the particles and the float may become jammed.

## 3.0 Reference Information

This section presents an overview of the operation of the Single or Multi-Point Vertically Mounted Liquid Level Float Switch, including information on troubleshooting common problems, maintenance procedures, listings of agency approvals, and detailed physical, functional, and performance specifications.

### 3.1 Description

The Single or Multi-Point Vertically Mounted Liquid Level Float Switches are float actuated devices designed for vertical mounting in a tank or process vessel through bracket or flange mounted connections. This low cost switch is ideal for OEM applications where single or multiple point level alarms are desired in a dirty media environment.

### 3.2 Theory of Operation

Switching action is achieved through the use of a magnet attached to the float assembly and its interaction with a switch mechanism. Separating the magnet and the switch is a non-magnetic pressure tube.

As the liquid level changes, the float along with the float magnet moves. The magnetic field of the float magnet causes a change of state of the switch, making or breaking an electrical circuit.

### 3.3 Troubleshooting

The Single or Multi-Point Vertically Mounted Liquid Level Float Switch is designed and engineered for trouble-free operation. Common problems are discussed in terms of their symptoms and corrective actions as recommended.

#### 3.3.1 External Causes

Usually the first indication of improper operation is failure of the controlled equipment to function (e.g., pump will not start (or stop), signal lamps fail to light, etc). When these symptoms occur, whether at the time of installation or during routine service thereafter, check for the following potential external causes first:

- Blown fuses
- Tripped reset button(s)
- Open power switch
- Faulty equipment controlled by level switch
- Defective wiring to level switch



---

### 3.3.2 The Unit Causes

If a thorough inspection of these possible conditions fails to locate the cause of the problem, proceed to a check of the switch mechanism.

1. Disconnect power to the level switch.
2. Use an electrical continuity checker to determine if the switch is electrically functional. If the switch does not operate properly when electrically activated, the entire level switch must be replaced.
3. If the switch functions properly electrically but does not activate when the float changes position, remove level switch from service. Check the float assembly for obstructions or accumulation of particles which may cause binding. If binding is present in the float assembly and cannot be cleared by normal cleaning procedures, the entire control must be replaced.
4. If the complete level switch operates properly when removed from service, check to ensure that liquid is entering the tank or vessel. A closed valve or clogged pipeline may prevent movement of the liquid in the vessel.
5. Check the float to make sure it is buoyant in the liquid (tank or vessel must have adequate level).
6. If the float is determined to be filled with liquid or is collapsed, the entire level switch may be replaced. Do not attempt to repair the float.

If all of the components of the level switch are in operating condition, the trouble is likely located external to the level switch.

**NOTE:** When in doubt about the condition or performance of a Single or Multi-Level Vertically Mounted Liquid Level Float Switch control, consult the factory for further instructions.

## 3.4 Specifications

### 3.4.1 Float Specifications

Float Materials	Dimensions	Temperature	Pressure**	Min. Media Specific Gravity
316 Stainless Steel	2.5" X 4"	-40° to +500°F	150 psig	0.75

\*\* The level sensor is designed for "open tank" applications at atmospheric pressure conditions

### 3.4.2 Electrical Specifications

Signal Output	Switch Closure
Type of Contacts	SPST, SPDT
Type of Switches	Hermetically Sealed Dry Contact Reed Switch
Switch Rating	50 VA, 240 VAC/VDC Max. SPST
	100 VA, 240 VAC/VDC Max. SPST
	100 W, 240 VAC/VDC Max. SPDT

### 3.4.3 Switch Wiring Codes

Wiring Options	Group 1 SPST	Group 2 SPST	Group 3 SPDT
Common Wire	Black	None	Black
(Levels)	N.O. or N.C.	N.O. or N.C.	N.O. & N.C.
L1	Red	Red/Red	Red/White-Red
L2	Yellow	Yellow/Yellow	Yellow/ White-Yellow
L3	Blue	Blue/Blue	

#### Notes:

1. All SPST switches are set normally open in their "dry", "no level" condition unless otherwise specified. "White-Red" and "White-Yellow" denote single white wire with red or yellow stripes.
2. The single float can be used to activate two switch points, though these points must have a minimum separation of 1/8" (3mm). The maximum number of actuation levels depends on the wiring type selected.
3. Standard Lead wires are 24" long, 22 AWG, UL approved cable.

### 3.4.4 Custom Configurator - Actuation Dimensions

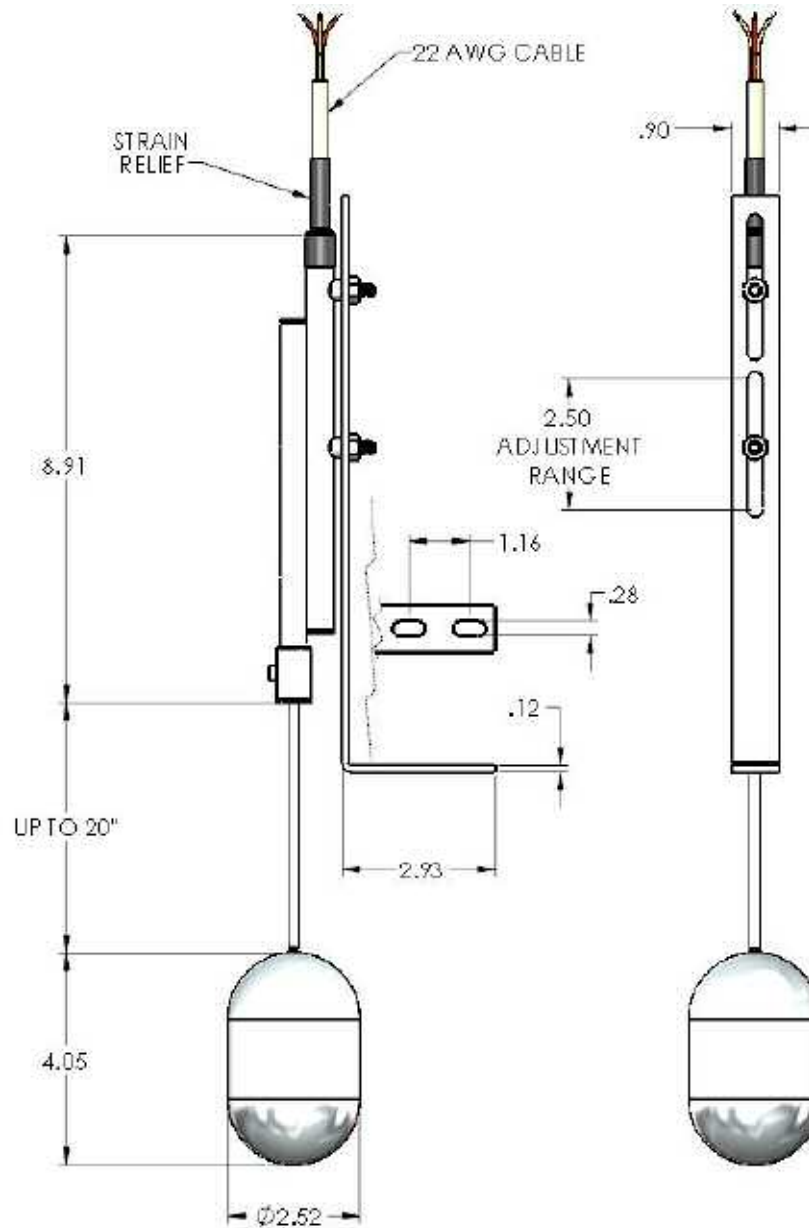

#### Notes:

1. When using one float for two actuation points, contact the factory for available switch ratings
2. Actuation levels are calibrated on descending fluid level, with water as the fluid, unless otherwise specified
3. Standard tolerance on actuation levels is  $\pm 1/8"$  (3mm)

### 3.5 Replacement Parts



Item	Description
1	Bracket
2	Float

**Important:**

Contact factory for ordering assistance on all replacement parts. There are many options available to choose from.

### 3.6 Product Configurator

TECHNOLOGY TYPE

S	Liquid level sensor for dirty environments
---	--

SERIES

003	"Trombone" Style
-----	------------------

IDENTIFIER

-	Standard Product
C	Custom Product

MOUNTING (CONTACT FACTORY FOR AVAILABLE OPTIONS)

00	Bracket
----	---------

STEM / BODY MATERIAL

08	316 SS
----	--------

FLOAT MATERIAL

08	316 SS
----	--------

SWITCH TYPES

03	50VA SPST
04	100VA SPST
14	100W SPDT

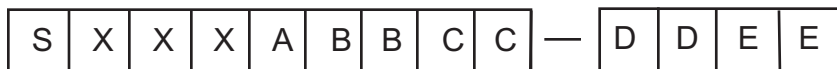

## Notes

## **Service Policy**

Owners of Innovative Solutions controls may request the return of a control or any part of a control for complete rebuilding or replacement. They will be rebuilt or replaced promptly. Controls returned under our service policy must be returned by Prepaid transportation. Innovative Solutions will repair or replace the control at no cost to the purchaser (or owner) other than transportation if:

1. Returned within the warranty period; and
2. The factory inspection finds the cause of the claim to be covered under the warranty.

If the trouble is the result of conditions beyond our control; or, is NOT covered by the warranty, there will be charges for labor and the parts required to rebuild or replace the equipment.

In some cases it may be expedient to ship replacement parts; or, in extreme cases a complete new control, to replace the original equipment before it is returned. If this is desired, notify the factory of both the model and serial numbers of the control to be replaced. In such cases, credit for the materials returned will be determined on the basis of the applicability of our warranty.

No claims for misapplication, labor, direct or consequential damage will be allowed.

## **Return Material Procedure**

So that we may efficiently process any materials that are returned, it is essential that a "Return Material Authorization" (RMA) number be obtained from the factory, prior to the material's return. This is available through Innovative Solutions local representative or by contacting the factory. Please supply the following information:

1. Company Name
2. Description of Material
3. Serial Number
4. Reason for Return
5. Application

Any unit that was used in a process must be properly cleaned in accordance with OSHA standards, before it is returned to the factory.

A Material Safety Data Sheet (MSDS) must accompany material that was used in any media.

All shipments returned to the factory must be by prepaid transportation.

All replacements will be shipped F.O.B. factory.

